

LEILA-R-CLIP16

Ø21.1 mm mini reflector with ~40° wide beam

TECHNICAL SPECIFICATIONS:

Dimensions	Ø 21.6 mm
Height	13 mm
Fastening	clips
Colour	white
Box size	
Box weight	4 kg
Quantity in Box	2400 pcs
ROHS compliant	yes ⓘ



MATERIAL SPECIFICATIONS:

Component	Type	Material	Colour	Coating
LEILA-R-CLIP16	Reflector	HRPC	white	

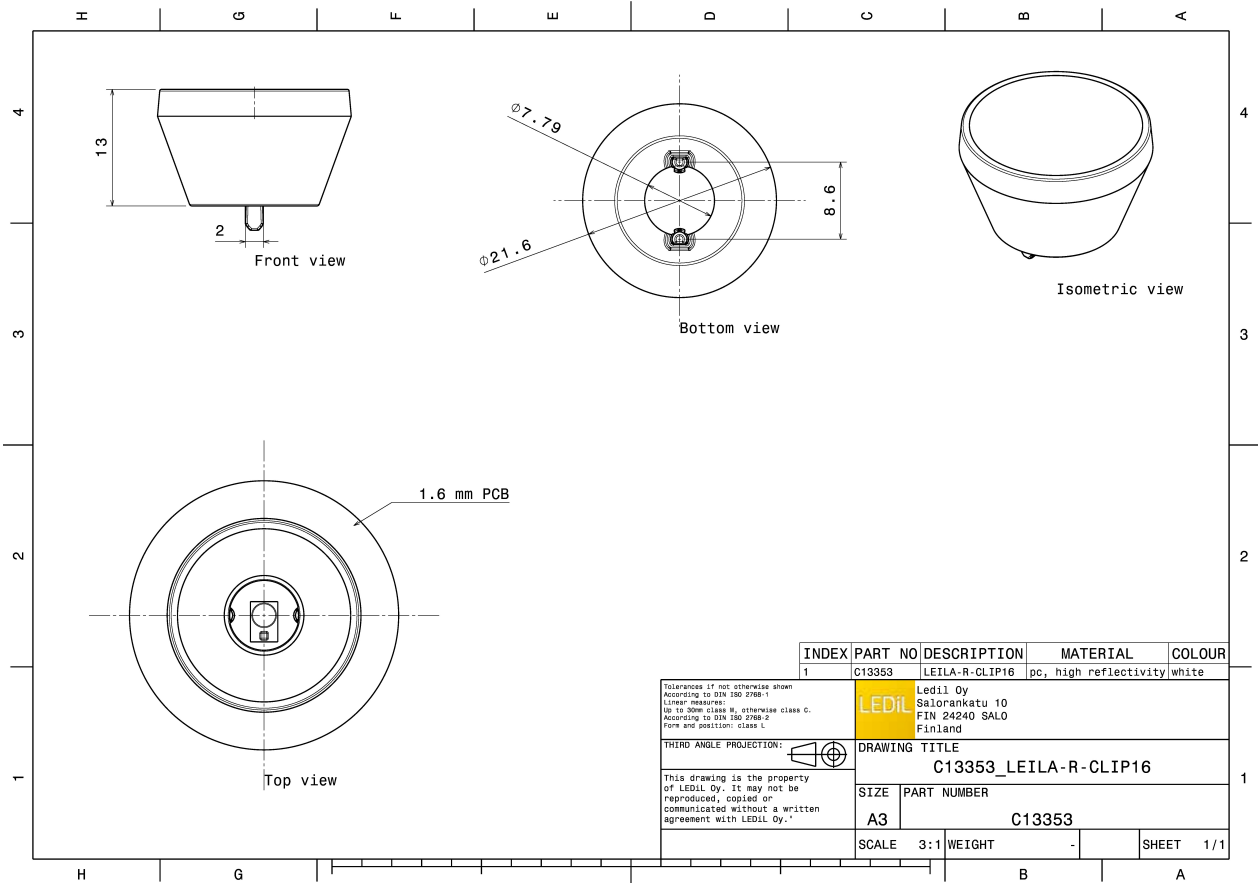

PHOTOMETRIC DATA (MEASURED):

CREE 

LED XB-D
FWHM 73.0°
Efficiency 92 %
Peak intensity 0.700 cd/lm
Required components:



CREE 

LED XM-L
FWHM 77.0°
Efficiency 90 %
Peak intensity 0.600 cd/lm
Required components:

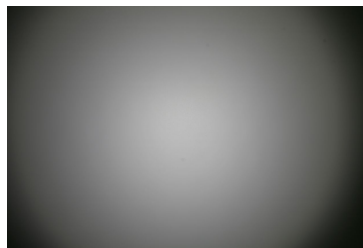

CREE 

LED XM-L2
FWHM 79.0°
Efficiency 92 %
Peak intensity 0.600 cd/lm
Required components:

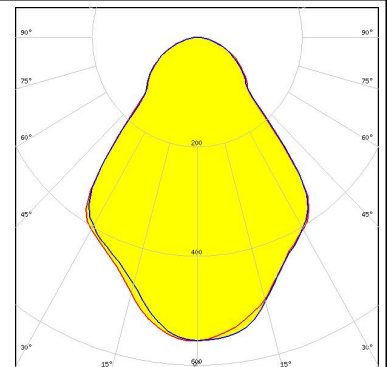
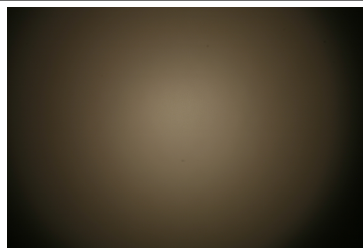

CREE 

LED XP-G2
FWHM 77.0°
Efficiency 92 %
Peak intensity 0.600 cd/lm
Required components:

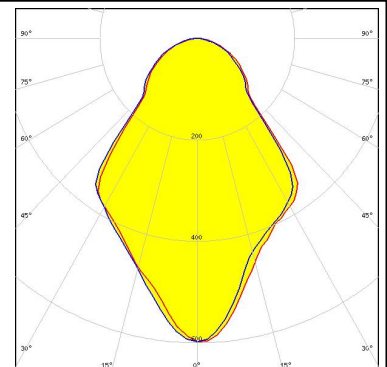
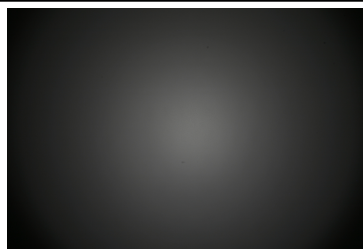

PHOTOMETRIC DATA (MEASURED):



LED XP-L HI
FWHM 74.0°
Efficiency 92 %
Peak intensity 0.640 cd/lm
Required components:

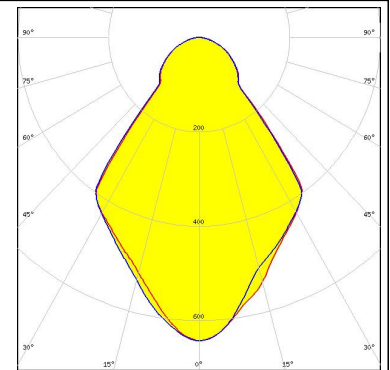

LED XT-E
FWHM 72.0°
Efficiency 93 %
Peak intensity 0.700 cd/lm
Required components:

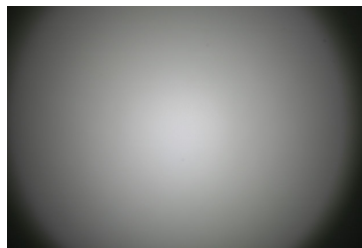

LED LUXEON A
FWHM 75.0°
Efficiency 93 %
Peak intensity 0.600 cd/lm
Required components:

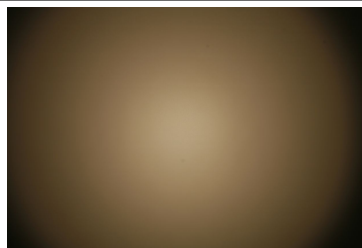

LED LUXEON C
FWHM 76.0°
Efficiency 92 %
Peak intensity 0.680 cd/lm
Required components:

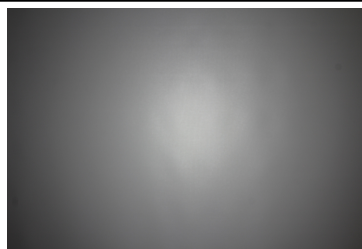

PHOTOMETRIC DATA (MEASURED):

LUMILEDS

LED LUXEON Q
FWHM 70.0°
Efficiency 88 %
Peak intensity 0.700 cd/lm
Required components:

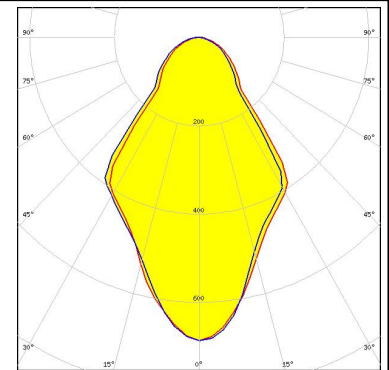
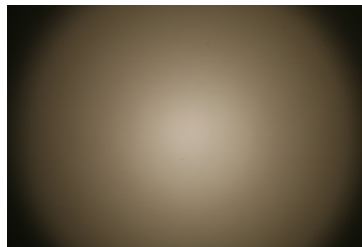

LUMILEDS

LED LUXEON R
FWHM 74.0°
Efficiency 93 %
Peak intensity 0.600 cd/lm
Required components:

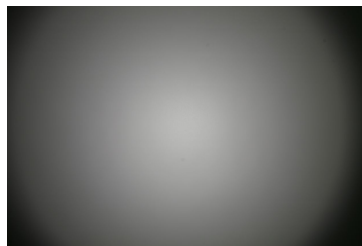

LUMILEDS

LED LUXEON Rebel
FWHM 73.0°
Efficiency 92 %
Peak intensity 0.700 cd/lm
Required components:



LUMILEDS

LED LUXEON Rebel ES
FWHM 74.0°
Efficiency 93 %
Peak intensity 0.600 cd/lm
Required components:

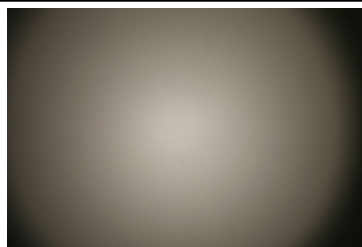

PHOTOMETRIC DATA (MEASURED):



LED LUXEON Z ES
FWHM 73.0°
Efficiency 92 %
Peak intensity 0.800 cd/lm
Required components:

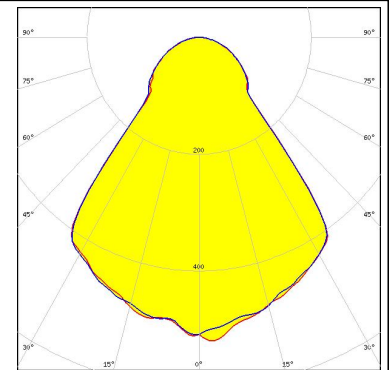
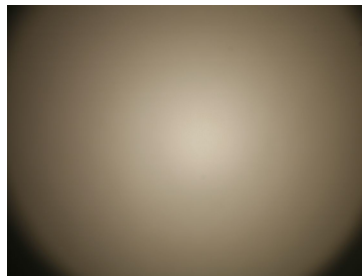

LED NCSxx19A
FWHM 72.0°
Efficiency 93 %
Peak intensity 0.600 cd/lm
Required components:

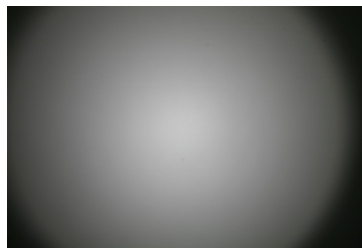

LED NF2x757A
FWHM 75.0°
Efficiency 92 %
Peak intensity 0.700 cd/lm
Required components:

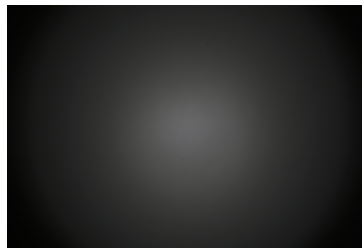

LED NS9x383
FWHM 74.0°
Efficiency 91 %
Peak intensity 0.600 cd/lm
Required components:

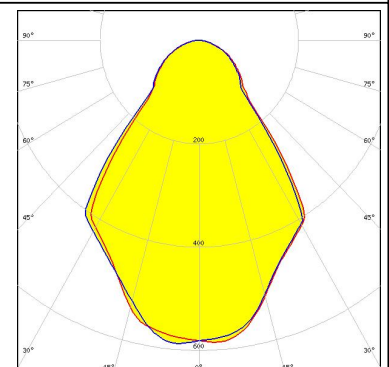
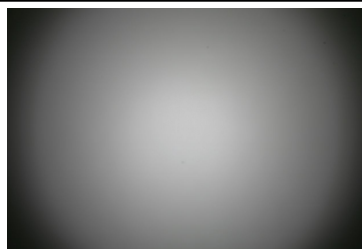

PHOTOMETRIC DATA (MEASURED):



LED NVSxx19A
FWHM 73.0°
Efficiency 93 %
Peak intensity 0.600 cd/lm
Required components:



LED Oslon Square PC
FWHM 74.0°
Efficiency 93 %
Peak intensity 0.600 cd/lm
Required components:

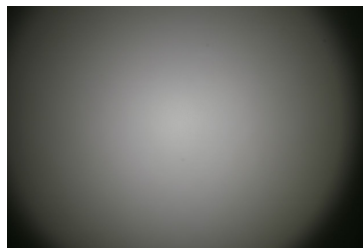

SEOUL SEMICONDUCTOR

LED Z8Y15
FWHM 71.0°
Efficiency 91 %
Peak intensity 0.714 cd/lm
Required components:

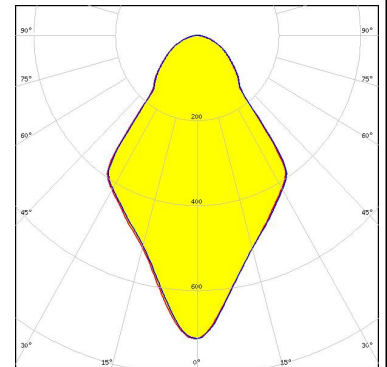

SEOUL SEMICONDUCTOR

LED Z8Y19
FWHM 71.0°
Efficiency 91 %
Peak intensity 0.686 cd/lm
Required components:

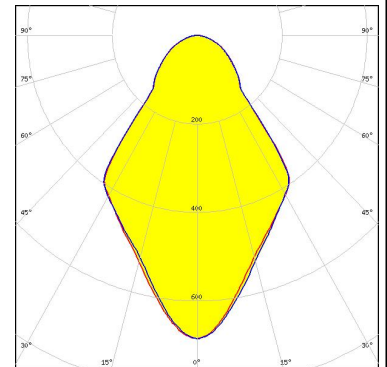

GENERAL INFORMATION:

NOTE: The typical beam angle will be changed by different color, chip size and chip position tolerance. The typical total beam angle is the full angle measured where the luminous intensity is half of the peak value.

MATERIALS:

As part of our continuous research and improvement processes, and to ensure the best possible quality and availability of our products, LEDiL reserves the right to change material grades without notice.

PRODUCT DATA USER AGREEMENT AND DISCLAIMER:

The measured data in the provided downloadable LEDiL Product Datasheets and Mechanical 2D-Drawings is rounded and provided as reference for planning. LEDiL Oy's optical specifications have been verified by conducting performance testing of the products in accordance with the company's quality system. The reported data are averaged results of multiple measurements with typical variation. LEDiL Oy reserves the right to without prior notification make changes and improvements to its products.

LEDiL Oy assumes neither warranty, nor guarantee nor any other liability of any kind for the contents and correctness of the provided data. The provided data has been generated with highest diligence but the provided data may in reality not represent the complete possible variation range of all intrinsic parameters. Therefore, in certain cases a deviation from the provided data could occur.

LEDiL Oy reserves the right to undertake technical changes of its products without further notification which could lead to changes in the provided data. LEDiL Oy assumes no liability of any kind for the possible deviation from any provided data or any other damage resulting from the usage of the provided data.

The user agrees to this disclaimer and user agreement with the download or usage of the provided files.

LEDiL Oy

Joensuunkatu 13
FI-24240 SALO
Finland

LEDiL Inc.

228 West Page Street
Suite D
Sycamore IL 60178
USA

Local sales and technical support

[www.ledil.com/
where_to_buy](http://www.ledil.com/where_to_buy)

Shipping locations

Salo, Finland
Hong Kong, China

Distribution Partners

[www.ledil.com/
where_to_buy](http://www.ledil.com/where_to_buy)