

ELV. RoHS COMPLIANT

1

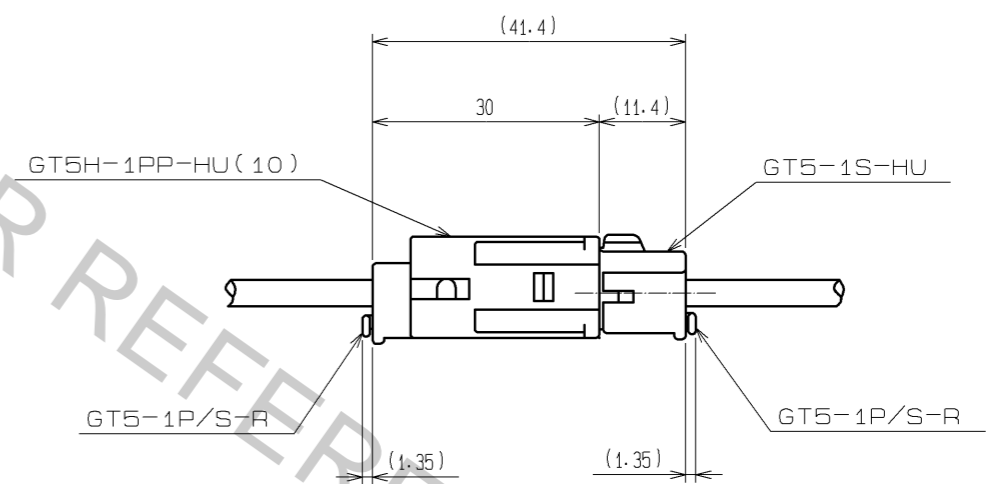
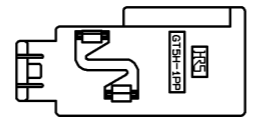
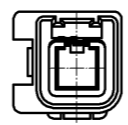
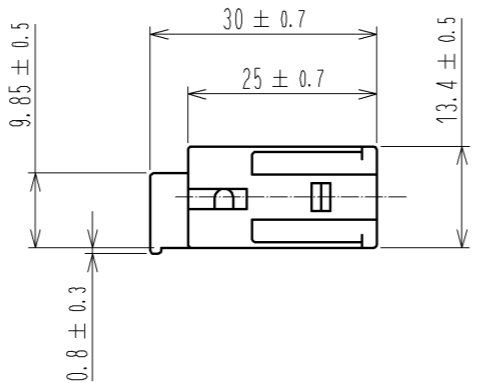
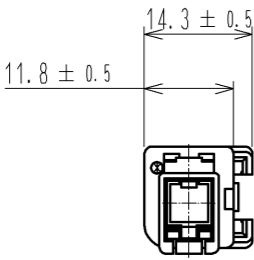
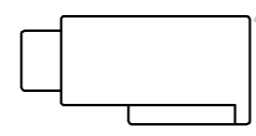
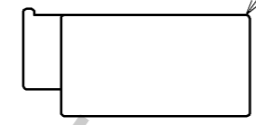

MATED CONNECTORS

NOTE. 1 THIS CONNECTOR SHALL BE USED WITH RETAINER (CL755-0006-2) ASSEMBLED.

1	PBT	UL94HB, LIGHT GRAY			
NO.	MATERIAL	FINISH, REMARKS	NO.	MATERIAL	FINISH, REMARKS
UNITS		SCALE	COUNT	DESCRIPTION OF REVISIONS	
mm		1 : 1		DESIGNED	CHECKED
HRS HIROSE ELECTRIC CO., LTD.		APPROVED : AR. SHIRAI	11.11.01	DRAWING NO. EDC3-165680-01	
		CHECKED : MO. OKADA	11.11.01	PART NO. GT5H-1PP-HU(10)	
		DESIGNED : RZ. KANO	11.11.01	CODE NO. CL755-0093-7-10	
		DRAWN : RZ. KANO	11.11.01		

Apr.1.2017 Copyright 2017 HIROSE ELECTRIC CO., LTD. All Rights Reserved.